



TERAFEST®

PREMIUM PRODUCTS

D E C K I N G

F E N C E S | C L A D D I N G

WWW.WOODPLASTIC.EU



FOREST



cedar



teak

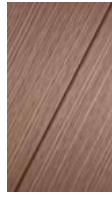

palisander

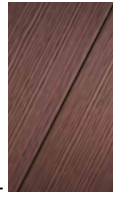

wenge

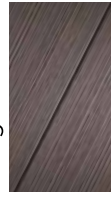

inox



eben



PREMIUM
MAX



137 x 22 mm



195 x 22 mm

← s → 4 m

← A → 2-6 m



3,3 kg / 1m

4,6 kg / 1m



FOREST PLUS*



cedar



teak



merbau



palisander



inox

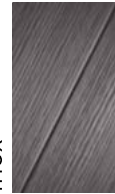

PREMIUM



137 x 22 mm

137 x 22 mm

← s → 4 m

← A → 2-6 m



3,3 kg / 1m

*PLUS - extra brindle finish



STAR



teak



palisander



inox

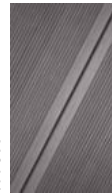

eben

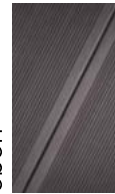

PREMIUM



137 x 23 mm

137 x 23 mm

← s → 4 m



3,4 kg / 1m



NEW

NATUR PLUS*



teak



palisander

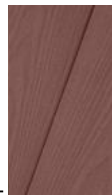

inox

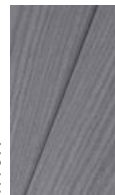

PREMIUM



137 x 23 mm

137 x 23 mm

← s → 4 m



3,5 kg / 1m

*PLUS - extra brindle finish



RUSTIC



teak

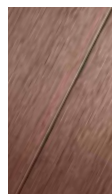

palisander

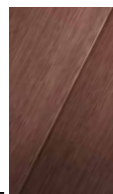

wenge

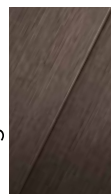

inox

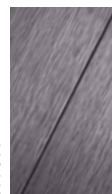

eben



TOP
MAX



140 x 22 mm

195 x 22 mm

← s → 4 m

← A → 2-6 m



3,3 kg / 1m

4,6 kg / 1m

FENCES / CLADDING / BOARDS



FENCE 120 FOREST PLUS

FENCE 120

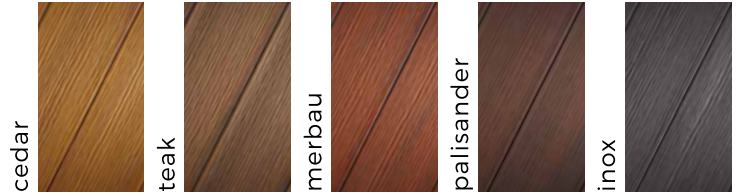



↗ ↘ ↙ ↚ 120 x 11 mm ← s → 3,6 m  1,7 kg / lm

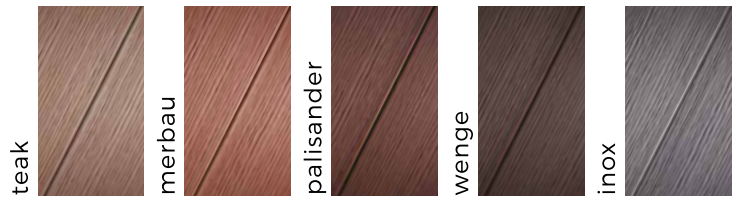

ECO CLADDING FOREST

ECO



↗ ↘ ↙ ↚ 150 x 14 mm ← s → 3,1 m  2,1 kg / lm

BOARDS SMOOTH/ FOREST

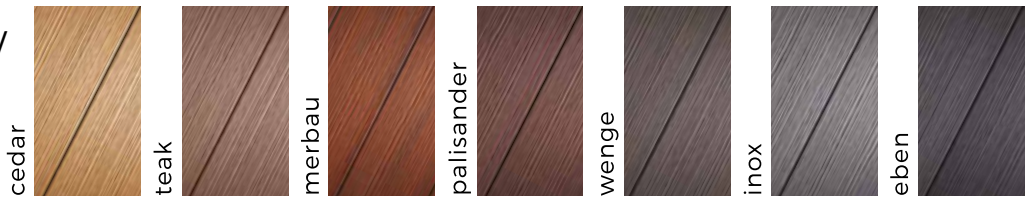

↗ ↘ ↙ ↚ 70 x 16 mm 90 x 16 mm ← s → 2 m  1,4 kg / lm 1,7 kg / lm

FOREST/ RUSTIC

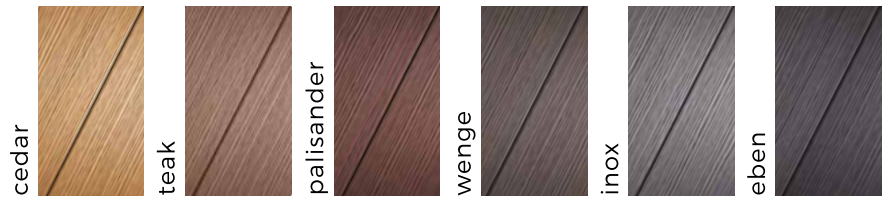

↗ ↘ ↙ ↚ 120 x 11 mm 150 x 19 mm ← s → 3 m 4 m  1,7 kg / lm 3,4 kg / lm



PROFILES / ACCESSORIES

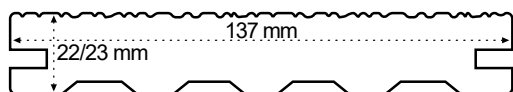

PREMIUM 

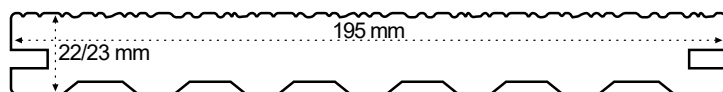

MAX 

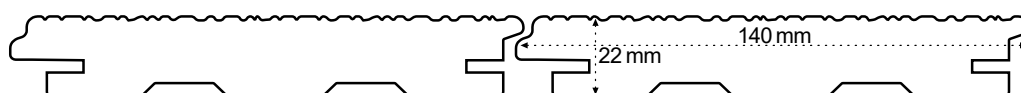

TOP 

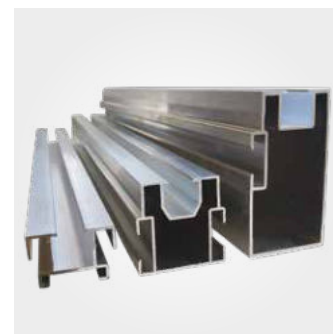
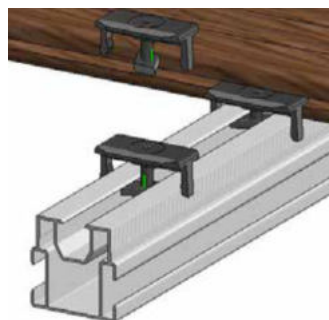

CLIPS, SCREWS and JOISTS

Stainless steel clips and screws are used to easily fix the boards to the joists. You can choose either aluminium SMART or WPC joists.

Large joist: 50 x 50 x 3000/4000 mm, 2,3 kg/lm

Small joist: 50 x 30 x 3000/4000 mm, 1,4 kg/lm

SMART —ALUMINIUM FIXING SYSTEM

The SMART system offers all the necessary components to assembly your decking –joists, clips and other fastening material.

Joist 23: 23 x 35 x 4000 mm, 0,39 kg/lm

Joist 40: 40 x 42 x 4000 mm, 0,67 kg/lm

Joist 75: 75 x 40 x 4000 mm, 1,10 kg/lm

COLOR AGING



AFTER
INSTALLATION

1 MONTH

25 YEARS

INFORMATION ABOUT THE MATERIAL

WoodPlastic® material combines wood (60%) and a high quality, non toxic HDPE polymer (40%) at just the right ratio. The material is highly resistant toward rain, snow, frost, UV, salt and chlorinated water.



MANUFACTURED IN EUROPEAN UNION

WoodPlastic® products are made in the European Union with and American license.

UP TO 25 YEARS WARRANTY

We trust in our Woodplastic® products. That's why we provide a warranty lasting up to 25 years.

ANTI-SLIP SURFACE

WoodPlastic® decking has an anti-slip surface, and unlike wood, it never splinters.

NO PAINTING

WoodPlastic® decking requires no waxing or oil coating.

ECOLOGY-PVC FREE

WoodPlastic® decking do not contain PVC and are 100% recyclable.

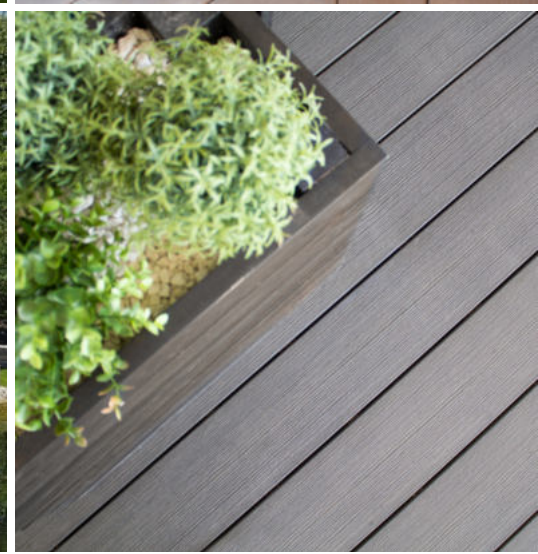

7 REASONS WHY YOU SHOULD CHOOSE DECKING TERAFAST®

YOU SAVE BOTH TIME AND MONEY THANKS TO THE DECKING'S LOW MAINTENANCE REQUIREMENTS. IT REQUIRES NO WAXING OR OIL COATING.

MADE IN THE EUROPEAN UNION.

ENVIRONMENTALLY FRIENDLY, 100% RECYCLABLE MATERIAL, PEFC – ENVIRONMENTAL CERTIFICATION.

THE DECKING HAS A SOLID PROFILE WITH COLOR COVERING THE ENTIRE SURFACE. THE DECKING IS ALSO COLOR RESISTANT MEANING ITS QUALITY WON'T CHANGE OVER TIME.

SAFETY IS GUARANTEED BY THE DECKING'S ANTI-SLIP SURFACE, WHICH NEVER SPLINTERS. A SAFE, HIDDEN FASTENING SYSTEM IS ALSO INCLUDED.

THE PRODUCT IS RESISTANT TOWARD RAIN, SNOW, FROST, UV, SALT AND CHLORINATED WATER.

ITS SURFACE IS ATTRACTIVE AND PLEASANT TO THE TOUCH.

WPC – WOODPLASTIC a.s.

BUKOVANY 181 | 257 41 TÝNEC NAD SÁZAVOU | CZECH REPUBLIC
+420 321 001 523 | WPC@WOODPLASTIC.EU | WWW.WOODPLASTIC.EU